



6 Holding an immunization session

About this module...

This module describes the tasks that the health worker must perform on the day of the immunization session, to ensure to quality sessions. It starts with the preparation needed before infants and women arrive at the immunization site and details on how to assess infants and women. It discusses the correct technique for giving each vaccine. It also describes how to communicate with parents during and after the immunization session and how to conclude the session.

Contents

1. Setting up an immunization session	3
1.1 Condition the ice-packs	3
1.2 Take the vaccines and diluents out of the refrigerator	3
1.3 Check if vaccines are safe to use	3
1.4 Prepare the vaccine carrier	4
1.5 Prepare the workplace	5
2. Assessing infants and women and completing the register	10
2.1 How to assess whether an infant is eligible for vaccines	10
2.2 Assessing infants and mothers for vitamin A supplementation	11
2.3 Assessing women for TT immunization	12
2.4 Contraindications to immunization	12
2.5 Completing the register	14
3. Giving the right vaccine safely	15
3.1 Reconstituting vaccines	15
3.2 Reconstituting BCG, measles, MMR, MR, Yellow fever, Japanese encephalitis, and Hib vaccines	16
3.3 Reconstituting DTP-HepB+Hib vaccine	18
3.4 Administering vaccine for infants	19
3.5 How to give an injection using AD syringes	20
3.6 BCG vaccine: intradermal (ID) injection in arm	20
3.7 DTP or DTP-HepB or HepB, Hib vaccine: intramuscular (IM) injection in thigh ...	22
3.8 Measles vaccine, yellow fever, JE: subcutaneous (SC) injection	23
3.9 OPV administration	23
3.10 TT vaccine (for women): intramuscular (IM) injection in the left arm	23
3.11 Vitamin A supplementation	24
4. Completing the tally sheet and infant’s immunization card	25
4.1 Recording the vaccines and vitamin A supplement given on the tally sheet	25
4.2 Completing the infant immunization card	25
4.3 Immunization cards for women	26
5. Communication with parents during and after the immunization sessions .	27
5.1 Here is a step-by-step guide to talking about immunization with parents at a session	27
5.2 Advising on potential side-effects	28
6. Concluding the session	29
6.1 Completing an immunization tally sheet	29
6.2 Taking care of the vaccines	29
6.3 Taking care of vitamin A capsules	29
6.4 Disposing of used equipment	29
6.5 Special tasks on completing an outreach session	30

1 Setting up an immunization session

Before the infants come for the immunization session you need to complete certain tasks explained below.

1.1 Condition the ice-packs

Conditioning ice-packs before the session is very important especially to prevent freeze-sensitive vaccines from freezing. To do this properly, you will need to remove frozen ice-packs from the freezing compartment at least 30 minutes before the session begins and allow the ice-packs to sit at room temperature until the ice begins to melt and water starts to form inside. You should check if an ice-pack has been conditioned by shaking it and listening for water inside.

1.2 Take the vaccines and diluents out of the refrigerator

Before you open the refrigerator door, decide how many vials of each vaccine you will need for the session (refer to Module 5, Table 5.5 and Table 5.6).

The first time you open the fridge in the morning, record the temperature inside the refrigerator. You must minimize the number of times you open the refrigerator door and the time the refrigerator door is left open.

From the refrigerator, select and use vaccines in this order:

1. Opened vials kept in the “use first” box in the refrigerator (if your country has adopted a multi-dose vial policy, see Module 3).
2. Unopened vaccine ampoules/vials that have been taken to outreach sessions and have been outside of the refrigerator, then returned (but not opened) to the refrigerator.
3. Vaccines with VVMs that have started to change.
4. The oldest vaccines that have not yet passed their expiry dates.

1.3 Check if vaccines are safe to use

Before you use any vaccine you must:

1. Check the labels of the vaccine and diluent. If the label is not attached, discard the vial or diluent.
2. Check the expiry date. You must discard vials and diluents if the expiry date has already passed.
3. Check the vaccine vial monitor (VVM). If it indicates the vaccine has passed the discard point, you must discard it immediately (Figure 6A).

Figure 6A: Vaccine vial monitors showing different stages

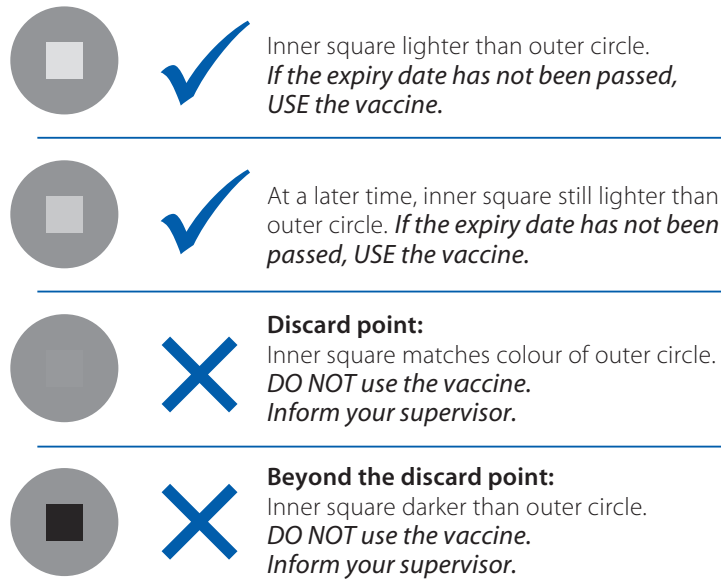

4. Check the freeze indicator in the refrigerator. If it warns of freezing or you suspect that a freeze-sensitive vaccine (DTP, DT, TT, Td, HepB, DTP-HepB, liquid Hib and DTP-HepB+Hib vaccines) has been frozen, you should perform the shake test (follow the steps given in Module 3 Section 8).

1.4 Prepare the vaccine carrier

Place conditioned ice-packs in the vaccine carrier as shown in Figure 6B. Place the vaccines and diluents into the vaccine carrier and close the lid tightly. If you use ice instead of ice-packs, you must always put ice cubes in a sealed plastic bag. The bag prevents water from collecting in the bottom of the carrier when the ice melts. During immunization sessions, keep opened vials inserted through the foam pad of your vaccine carrier. The foam pad keeps vaccines inside the carrier cool while providing a place to hold and protect vials in use. Do not cover the vials with ice.

Figure 6B: Packing a vaccine carrier

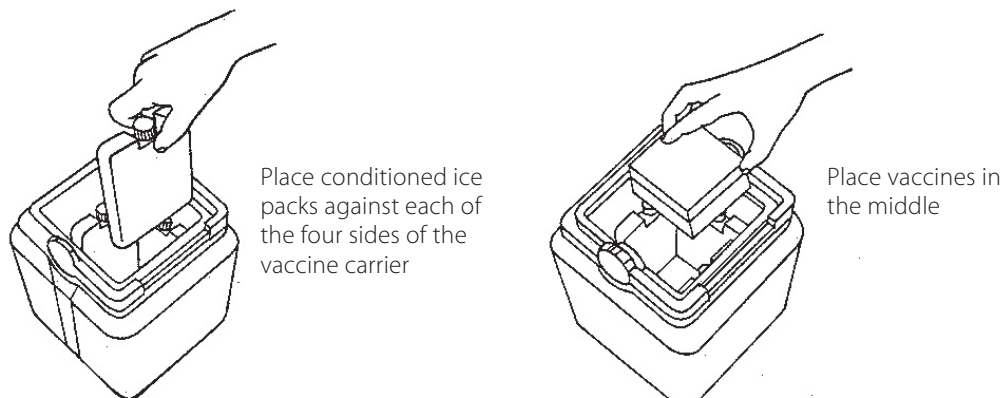

1.5 Prepare the workplace

1.5.1 Arranging space in fixed health facilities for immunization sessions

The arrangement of the space in your health facility will affect how you work and how quickly women and infants finish the immunization process. The space that you set up for immunization should be:

- *easily accessible* to women and infants, but arranged so that they are not crowding the immunization area;
- in a clean area *not directly exposed to sunlight, rain, or dust*;
- *convenient for the health worker* who is preparing and giving doses of vaccines; and
- *quiet enough* for you to be able to explain what you are doing and to give advice.

Put up a sign saying “immunization clinic” to show people where to come and wait.

The fixed health facility should have:

- space in the shade where women and infants can sit before receiving doses of vaccine;
- space and equipment for screening, registration, immunizing, and recording;
- a table for vaccines and injection equipment;
- a chair on which a mother can sit while holding a child for immunization; and
- a chair for the health worker.

If you provide other services during immunization sessions, you need space and equipment for them as well. Set up a separate station for each of these services, which may include:

- weighing babies and charting their growth;
- treatment;
- antenatal care;
- health education.

**Planning patient movement through the immunization facility to increase safety**

Part of setting up a safe immunization site involves planning patient flow to reduce the risk of accidental needle stick injury to the health worker or member of the community. For a safe clinic, keep the following guidelines in mind:

- If possible a room with two doors should be used (see Figure 6C). The patients should enter through one door and exit through another so that health workers are able to move people from the table where their names are checked to the immunization table, then over to the health information table, then finally the exit.
- If the facility only has one door the health worker should allow the person or child being immunized and the parent(s) to enter, receive their vaccination and then leave before allowing another person into the immunization clinic area.
- If possible, separate the registration tables from injection tables to help keep children calm.
- If other health care services are being provided, they should be incorporated into the flow, for example infant weighing table, nutrition table, and antenatal care.
- Whenever possible women and infants to be immunized should be separated from those who have just been immunized so the people waiting are not distressed by babies and children crying.
- A community member or another health worker should tell the community how they will move through the immunization facility. This person should also monitor the movement during the immunization session to ensure the patient flow is safe and efficient.

1.5.2 Gather equipment for the immunization session

The amount of equipment you need for the session depends on the estimated number of women and infants who will be immunized. Basic estimates for vaccines, AD syringes, mixing syringes, needles and safety boxes are provided in Module 5.

Basic list of other equipment and supplies needed for fixed and outreach sessions:

- | | |
|--|------------------------------------|
| • soap for hand washing | • cotton |
| • metal file to open ampoules | • container for rubbish |
| • immunization register | • immunization tally sheets |
| • new immunization cards for women and infants | • paper, pencils, and pens |
| • safety box | • table(s) |
| | • stool(s) / chair(s) for sitting. |

Figure 6C: Set-up for an immunization session at a fixed site

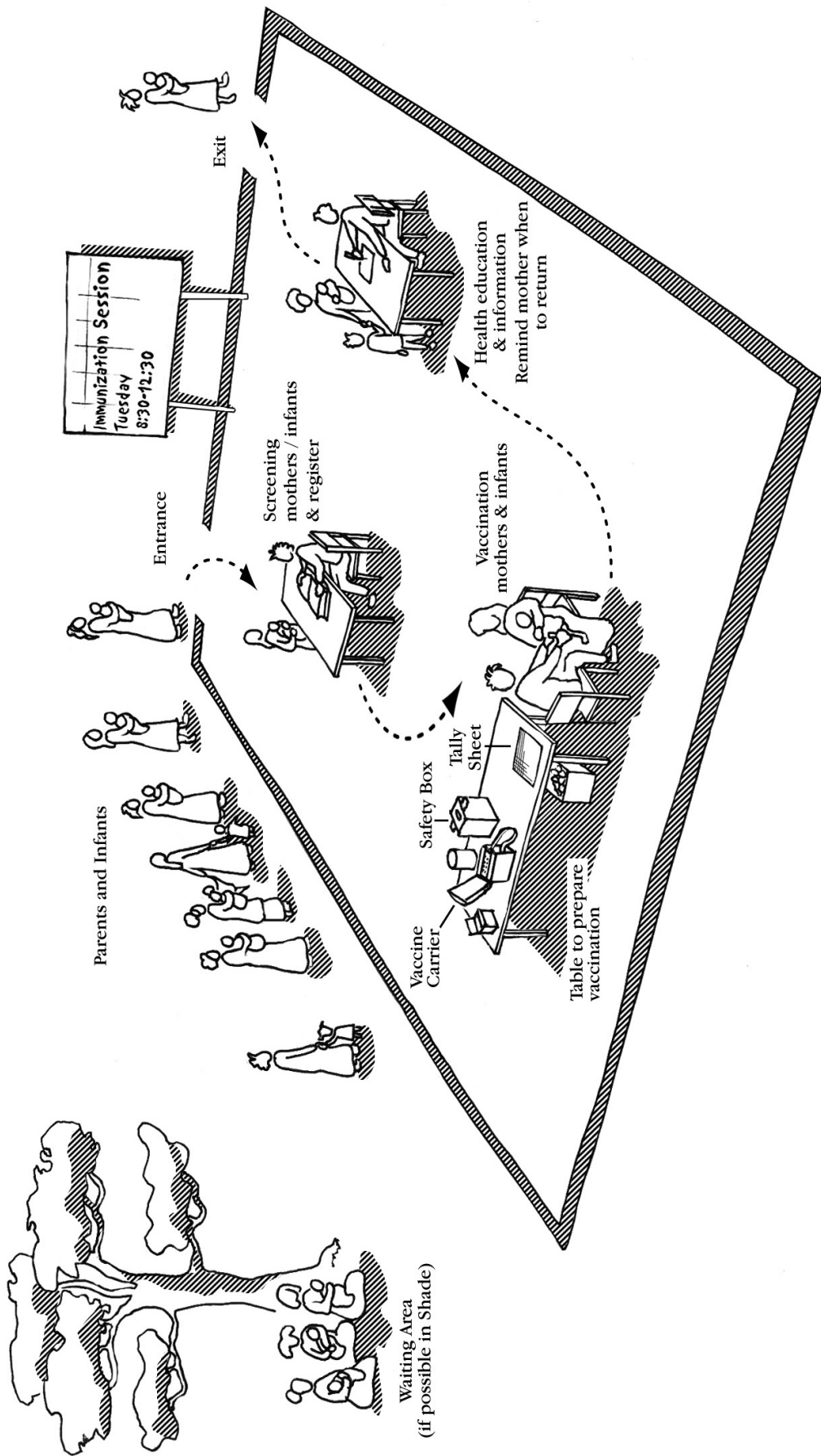
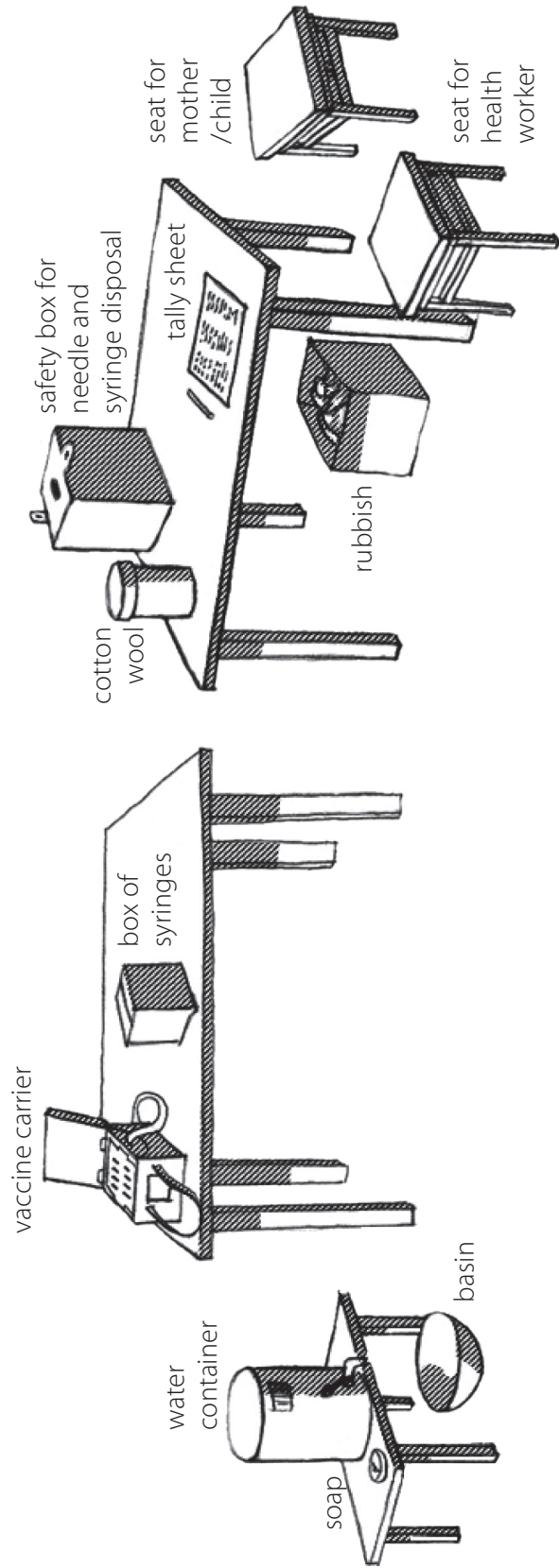

Figure 6D: Layout of the immunization workspace



Health workers should plan the layout (see Figure 6D) of the immunization work space such that:

- Where possible there is a separate table for immunization and another for health checks if these are taking place at the same time as vaccination.
- The health worker is between the infant and all needles or sharp objects.
- Each person giving injections has her/his own safety box at busy sites.
- The health worker can dispose of used needles without setting them down or moving around with them.
- Only one child with a parent (or person to be vaccinated) at a time is near the work space.
- The hand-washing equipment is placed next to the immunization table. Health workers must wash their hands prior to giving the first immunization and when in contact with dirt or blood.
- The health worker can tally the vaccine given soon after the vaccine is administered.

1.5.3 *Setting up an outreach site*

The place where you give immunizations during an outreach visit may be in a building or in the open air. If in a building it should be well lighted and well ventilated. If in the open air and in a hot climate it should be in the shade.

In arranging the immunization site, make sure that:

- there is a separate entrance and exit so that people may move in and out of the session more quickly and easily;
- the waiting area is clean, comfortable, and, in a hot climate, out of the sun;
- people are effectively guided to the entrance, the stations and the exit by means of signs or the arrangement of chairs, tables, ropes or other items;
- the number of people at the immunization and other stations are limited, so there is no crowding;
- everything you need is within reach on or near your immunization table.

Figure 6E: Outreach immunization site in the open air



2 Assessing infants and women and completing the register

2.1 How to assess whether an infant is eligible for vaccines

Whenever infants visit the health centre they should be screened for immunization and given all of the vaccines they are eligible to receive. When an infant is brought to the health centre, you must determine his/her age and previous immunization status before deciding which vaccine doses to provide and whether the infant is eligible to receive vitamin A supplementation.

1 Determine the infant's age

- Look at the infant's immunization card to determine the infant's age.
- If the infant does not have an immunization card, ask the mother how old the infant is.
- If the mother does not know the infant's age, estimate it by asking if the infant was born during a notable community event, for example during a certain season or celebration. This will give you a better idea of the infant's age. Infants above 1 year of age and who are not fully vaccinated, should still receive the missing doses (usually countries set 23 months as the upper limit, but this limit can be higher). Such doses should be tallied separately (see Module 7).

2 Determine which vaccines the infant has received

- Look at the infant's immunization card to see which vaccines he/she has already received.
- If the infant does not have an immunization card, ask the mother which vaccines he/she has already received.
- Check the register where you may find records of the infant's earlier doses of vaccines.
- If the mother does not know if the infant has been immunized or there is no record in the immunization register, give doses of all eligible vaccines (see step 3).
- A scar on the infant's left arm or shoulder indicates he/she has received BCG vaccine. If the infant does not have a scar and you cannot determine whether a dose of BCG has been given, immunize the infant with BCG vaccine.

3 Determine all vaccines for which the infant is eligible

Decide which vaccines the infant is eligible to receive according to your national schedule (see Module 2 for the WHO recommended schedule).

Follow the general guidelines given below:

1. If the infant is eligible for more than one type of vaccine, the vaccines may all be given at the same session, but at different injection sites.
2. Never give more than one dose of the same vaccine at one time.
3. If the delay between doses exceeds the minimum delay, do not restart the schedule. Simply provide the next needed dose in the series. For example, an 18 month old who has received only BCG, OPV1, and DTP1 should receive OPV2, DTP2, measles, and yellow fever vaccines. Inform the mother of the importance of bringing the infant back to the health facility in four weeks to receive OPV3 and DTP3 vaccines.
4. If there is a delay in starting primary vaccination, immunize the infant while maintaining the recommended dosage intervals.
5. For practical reasons, most countries do not offer the primary series of routine immunization beyond 23 months (refer to national policy).

2.2 Assessing infants and mothers for vitamin A supplementation

If your country provides vitamin A supplementation during routine immunization, you must screen mothers and children younger than 5-years-old for vitamin A supplementation at every immunization contact.

- 1** Determine the infant's age (see Section 2.1, step 1 of this module) and/or whether the mother gave birth 6–8 weeks ago.
- 2** Check the infant's immunization card to see if he or she has received a vitamin A supplement and, if so, determine the interval since the last dose.

Ideally, infants and children should receive vitamin A doses of 100 000 IU (6–11 months) or 200 000 IU (12–59 months) every 4–6 months. Repeat supplementary doses should never be less than 4 weeks apart unless the child is being treated for measles or eye signs of VAD.

If vitamin A was distributed during NIDs in your program area within the past four months:

- Assume that all infants and children 6–59 months of age have received a dose (or 12–59 months in countries where infants under 12 months are not given vitamin A with NIDs).
- Do not give another dose unless the caretaker says the child did not participate in NIDs.
- Do not look for records as vitamin A doses given at NIDs are not meant to be recorded due to the difficulty of recording at mass campaigns.

2.3 Assessing women for TT immunization

At any immunization session, especially outreach, you should offer routine TT immunization to pregnant women.

Some countries also have a policy of providing TT immunization to non-pregnant or recently pregnant women during routine infant immunization sessions.

To assess a woman's eligibility for TT immunization:

- First ask if the woman has a TT vaccination card. If she has, give the dose required according to the national TT schedule. If the woman does not have a record, ask her if she has ever had a dose of TT in the past:
 - If she says *NO*: give the first dose of TT and an appointment for the second dose one month later, and give her an immunization card.
 - If she says *YES*: ask how many doses she has received in the past and give the next doses in series (refer to Module 2 Section 5). Take into account any dose given in SIAs.
 - If she *cannot remember or does not know*, you should give her a dose of TT and a follow-up appointment for the next dose (refer to Module 2 Section 5).

Recording TT doses

Ideally the TT doses given to women should be kept in a separate register. The register can be used at antenatal clinics or other opportunities to vaccinate women. In some countries, the infant register is used to keep record of maternal TT doses (see Module 7).

Use every opportunity to offer TT immunization to women. Any TT dose given should be recorded on an immunization card that is kept by the women.

At all antenatal clinics, outreach, fixed and mobile sites, make sure women especially pregnant women are screened for TT eligibility and offered TT immunization and TT cards if needed.

2.4 Contraindications to immunization

There are not many contraindications to immunization. All infants should be immunized except in these three rare situations:

1. Anaphylaxis or a severe hypersensitivity reaction is an absolute contraindication to subsequent doses of a vaccine. Persons with a known allergy to a vaccine component should not be vaccinated.
2. Do not give BCG or yellow fever vaccine to an infant who exhibits the signs and symptoms of AIDS (see Table 6.1). Other vaccines should be given.
3. If a parent strongly objects to an immunization for a sick infant, do not give it. Ask the mother to come back when the infant is well.

Table 6.1: Recommendations for immunization of HIV-infected children and women of childbearing age

Vaccine	Asymptomatic HIV infection	Symptomatic HIV infection
BCG	vaccinate	Do not vaccinate
DTP	vaccinate	vaccinate
OPV	vaccinate	vaccinate
Measles	vaccinate	vaccinate
<i>H. influenzae</i> type b	vaccinate	vaccinate
Hepatitis B	vaccinate	vaccinate
Yellow fever	vaccinate	Do not vaccinate ^a
Tetanus toxoid	vaccinate	vaccinate

^a pending further studies

The following are *not* contraindications. Infants with these conditions *should* be immunized:

- allergy or asthma (with the exception of a known allergy to a specific component of the vaccine mentioned above);
- any minor illness, such as respiratory tract infections or diarrhoea with temperature below 38.5°C
- family history of adverse events following immunization
- family history of convulsions, seizures, or fits;
- treatment with antibiotics;
- known or suspected HIV infection with no signs and symptoms of AIDS;
- signs and symptoms of AIDS, except as noted in Table 6.1;
- child being breast fed;
- chronic illnesses such as chronic diseases of the heart, lung, kidney, or liver
- stable neurological conditions, such as cerebral palsy or Down's Syndrome;
- premature or low-birthweight (vaccination should not be postponed);
- recent or imminent surgery;
- malnutrition; and
- history of jaundice at birth.

If a reaction does occur, health workers should report the problem to supervisors immediately. Children who have a severe reaction to a vaccine should not receive additional doses of that vaccine.

There is no evidence of risk to the fetus from immunizing pregnant women with tetanus toxoid.

2.4.1 Immunizing sick infants

Many health workers do not like to immunize an infant who is ill. Young infants have many illnesses, and immunization is often delayed. Many infants catch one of the target diseases because they missed being immunized due to illness. However, we now know that it is safe to immunize infants even if they are ill.

Children with a mild illness

Immunize them as usual.

Children with a fever

Immunize them as usual. You can give any vaccine, including DTP – there is no danger from adding the reaction to vaccine to a moderate fever.

Very ill infants who need to go to hospital, or infants who have a very high fever

Immunize them if possible. A senior health worker must decide for each individual infant. Remember that sick infants need protection against diseases that they may catch in hospital, especially measles.

Malnourished infants

You must immunize them – they can develop good immunity although they are malnourished.

They are more likely than other infants to die from the diseases (especially from measles).

2.5 Completing the register

Most health centres keep an immunization register. This helps health workers keep track of the immunization services they give to each infant and pregnant woman.

You must register pregnant women and infants as soon as they arrive at the health centre or outreach site. Fill in all blanks except the space for services provided. This space should be completed after the services are provided (see Module 7 for more details).



What to do when children attend outside normal session times

Many infants and women eligible for immunization have contact with health services and could be immunized if vaccines were offered. Furthermore, the increased risk for children of contracting measles in health facilities has been documented both in developing and industrialized countries, highlighting the importance of protecting them through immunization at every health service contact. Routine screening for immunization status should occur for all infants and women of childbearing age who visit health services for any reason. Ideally, eligible infants and women should be immunized immediately, but at a minimum, they should be given an appointment for immunization.

3 Giving the right vaccine safely

3.1 Reconstituting vaccines

Reconstituting vaccines means mixing a powdered form of a vaccine with a fluid called a diluent so that the vaccine can be injected.

The table below lists the vaccines that need to be mixed with diluent before use.

Table 6.2: Vaccines that require reconstitution

Vaccines that need to be reconstituted	Powder		Diluent
BCG	freeze-dried	vial	liquid provided with vaccine
Measles	freeze-dried	vial	liquid provided with vaccine
Measles-mumps-rubella (MMR)	freeze-dried	vial	liquid provided with vaccine
Measles-rubella	freeze-dried	vial	liquid provided with vaccine
Yellow fever	freeze-dried	vial	liquid provided with vaccine
Japanese encephalitis	freeze-dried	vial	liquid provided with vaccine
Hib ^a	freeze-dried	vial	liquid provided with vaccine
DTP-HepB+Hib	freeze-dried Hib	vial	liquid DTP-HepB vaccine

^a Hib vaccine is available in both dry powder and liquid form. If you are using the dry powder form, you **must** reconstitute it before the vaccine can be injected. If you are using the liquid form, you do not need to reconstitute the vaccine.

Follow the steps indicated below to mix most powder vaccines with a fluid so that the vaccine can be used. DTP-HepB+Hib requires a slightly different reconstitution process, explained in Section 3.3 of this module.

Remember:

- Diluent are not interchangeable, different vaccines have different diluents; mixing and administering the wrong diluent has led to serious adverse events including death.
- Always use diluent from the same manufacturer as the vaccine.
- Diluents should be cooled before being mixed with the vaccine
- Do not reconstitute vaccines until you are ready to immunize.
- You must discard reconstituted vaccine after six hours or at the end of the immunization session, whichever comes first.

3.2 Reconstituting BCG, measles, MMR, MR, Yellow fever, Japanese encephalitis, and Hib vaccines

1 Wash your hands

Wash your hands with clean water and soap before reconstituting vaccines.

2 Inspect the vaccine vial or ampoule

Most vaccines come in vials, except for BCG vaccine which comes in ampoules. A vial is a glass bottle with a rubber stopper held in place by a metal or plastic cap.

Check the vaccine vial monitor (if there is any) to ensure that the vaccine has not passed the discard point.

Read the expiry date on the label to make sure that you can still use the vaccine. If the date has passed, discard the vaccine.

3 Flick the vial or ampoule

Make sure that all of the vaccine powder is at the bottom of the vial. Flick or tap the vial with your finger.

4 Open the vaccine vial or ampoule

The centre of the metal cap is pre-cut so that it can easily be removed. Lift the centre of the metal cap and bend it back, using a metal file.

Some vials have coloured plastic caps instead of metal caps. Flip off the plastic cap with your thumb.

5 Inspect the diluent ampoule or vial

The diluent for reconstituting vaccines is usually held in ampoules, which are glass or plastic bottles that you open by breaking off their pointed tops. Make sure the ampoule is not cracked.

6 Read the label on the diluent ampoule or vial

Make sure that you are using the diluent the manufacturer sent with the vaccine and the expiry date has not passed.

Use only the ampoule or vial sent by the manufacturer for the specific powder vaccine. Do not use sterile water or saline provided for other purposes as a diluent. Each vaccine has its own diluent and must not be reconstituted with anything else.

7 Open the glass ampoule

Hold the ampoule between your thumb and middle finger.

Use your index finger to support the top.

Take the metal file that is packed with the ampoules and scratch hard around the neck of the ampoule you wish to open.

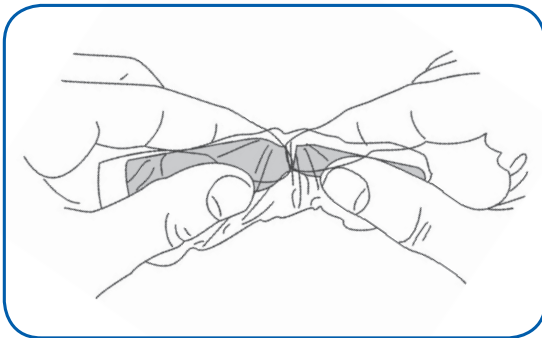
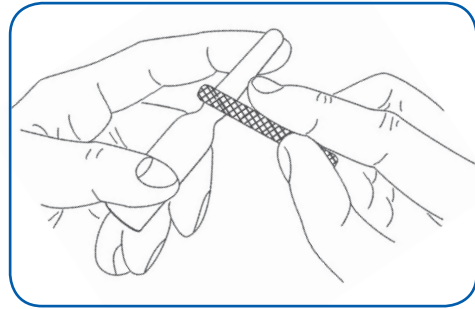

Hold the top of the ampoule in a piece of clean cloth and gently break off the top. It breaks where you made the scratch.

In case of injury while breaking the ampoule, discard the ampoule as the content may have been contaminated. Cover the wound/cut before opening a new ampoule.

8 Draw diluent into a mixing syringe

Use a new disposable mixing syringe (5 ml) and a mixing needle (76 mm, 18 gauge) to reconstitute each supply.

Put the needle in the open top of the ampoule.

Pull back the plunger to draw **all the diluent** from the ampoule into the syringe.

Do not reuse disposable mixing syringes.

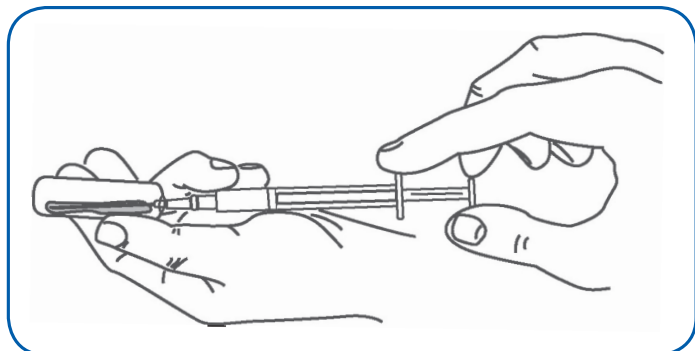

9 ▶ Reconstitute the vaccine

Insert the mixing syringe that is filled with diluent into the vaccine vial or ampoule.

Hold the plunger end of the mixing syringe between your index and middle fingers and push the plunger in with your thumb. This empties the diluent into the vaccine vial or ampoule.

- To mix the diluent and vaccine, draw them up slowly into the syringe and inject them slowly back into the vial or ampoule. Repeat several times.
- Put the mixing syringe and needle in a safety box after use.

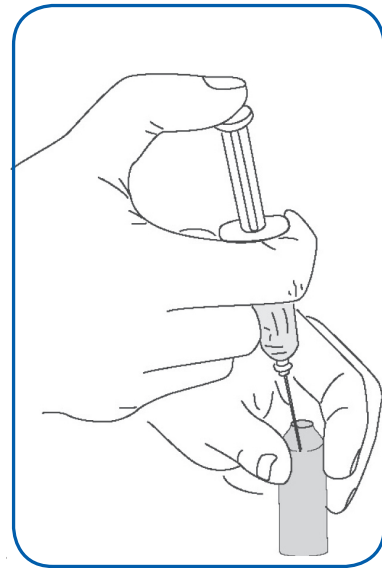

10 ▶ Handling reconstituted vaccines

Put the reconstituted vaccine on the foam pad of your vaccine carrier.

3.3 Reconstituting DTP-HepB+Hib vaccine

DTP-HepB+Hib vaccine is reconstituted differently from other vaccines. It is reconstituted using liquid DTP-HepB vaccine to reconstitute the powdered Hib vaccine.

1 ▶ Open the powder Hib vaccine vial

2 ▶ Draw liquid DTP-HepB vaccine into a mixing syringe

Draw up **all** the liquid DTP-HepB vaccine from the vial into a 5 ml mixing syringe.

3 ▶ Reconstitute the DTP-HepB+Hib vaccine

Inject all 1.3 ml of the DTP-HepB liquid vaccine from the 5 ml mixing syringe into the vial containing the powder Hib vaccine.

4 ▶ Discard all DTP-HepB+Hib reconstituted vaccine after six hours or at the end of the immunization session, whichever comes first.

3.4 Administering vaccine for infants





Name of vaccine	BCG	DTP or DTP-HepB, HepB	Measles/ yellow fever	OPV
Where given	Outer upper left arm or shoulder	Outer mid-thigh in infants/ outer upper arm if older	Outer mid-thigh/upper arm depending on the age	Oral
How given	Intradermal injection	Intramuscular injection	Subcutaneous injection	Oral dropper
Dose	0.05 ml	0.5 ml	0.5 ml	2 drops
Needle size	10mm, 26 gauge	25mm, 23 gauge	25mm, 23 gauge	
Type	Powder + Diluent	Ready-to-use	Powder + Diluent	Vial with oral dropper
Appearance	White, cloudy liquid with sediment that suspends when shaken (see shake test Module 3)	White, cloudy liquid with sediment that suspends when shaken (see shake test Module 3)	Clear, slightly yellow liquid	Clear, pink or orange liquid
				

Figure 6I: Different needle positions

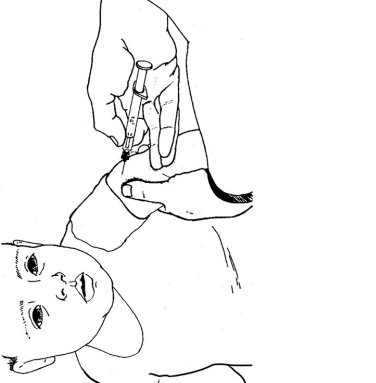

3.5 How to give an injection using AD syringes

1. Wash skin that looks dirty with water. It is not necessary to swab clean skin.
2. Hold syringe barrel between thumb, index and middle fingers. Do not touch the needle. The plunger can go back and forth only once, so health workers should not draw up air to inject into the vial as this will disable the syringe.
3. Insert needle with a smooth action.
4. It is not necessary to aspirate first.
5. Use thumb to push the plunger without moving the syringe around.
6. Pull needle out quickly and smoothly (less painful than doing it slowly).
7. Ask the parent to press the site gently with a clean swab for a few seconds (to stop bleeding and relieve pain).
8. Do not rub the area where the injection was given.

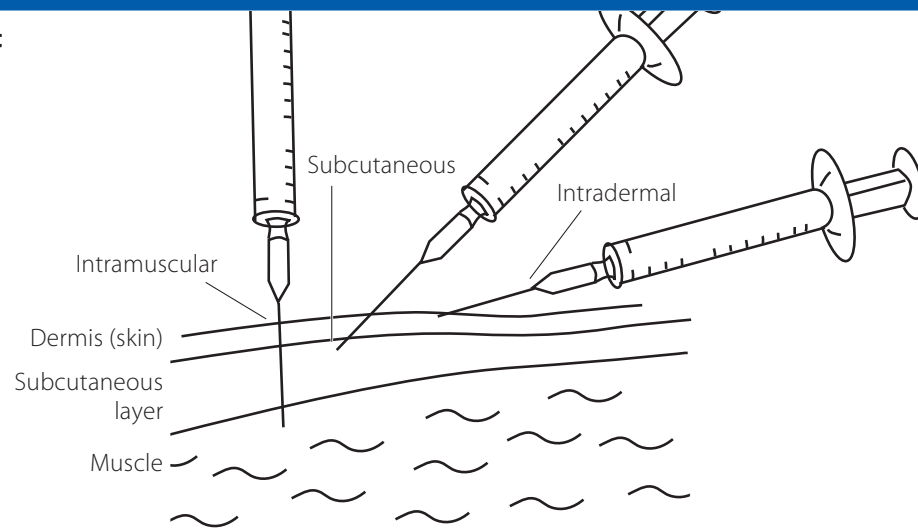
3.6 BCG vaccine: intradermal (ID) injection in arm

The injection is given into the skin in the **left upper arm**. The dose of BCG is very small (0.05 ml). To measure and inject such a small dose accurately you must use a special small syringe and needle.

BCG is the only childhood vaccine that is injected into the layers of skin for slow absorption (intradermally). To give an intradermal injection correctly you must use a short, very fine needle (10 mm, 26 gauge).

1. Position infant sideways on mother's lap and remove clothing from the arm and shoulder.
2. The mother should hold the infant close to her body, supporting his or her head and holding the arms close to the body.
3. Hold the syringe in your right hand with the bevel of the needle facing upwards.
4. Stretch the skin out flat with your left thumb and forefinger.
5. Lay the syringe and needle almost flat along the infant's skin.
6. Insert the tip of the needle just under the surface but in the thickness of the skin – just past the bevel (the hole in the end of the needle).
7. Keep the needle **FLAT** along the skin, so that it goes into the top layer of the skin only. Keep the bevel of the needle facing up.
8. Do not push too far and do not point down or the needle will go under the skin. Then it will be subcutaneous instead of an intradermal injection.
9. To hold the needle in position, put your left thumb on the lower end of the syringe near the needle, but do not touch the needle.
10. Hold the plunger end of the syringe between the index and middle fingers of your right hand. Press the plunger in with your right thumb.
11. Inject 0.05 ml of vaccine and remove the needle.

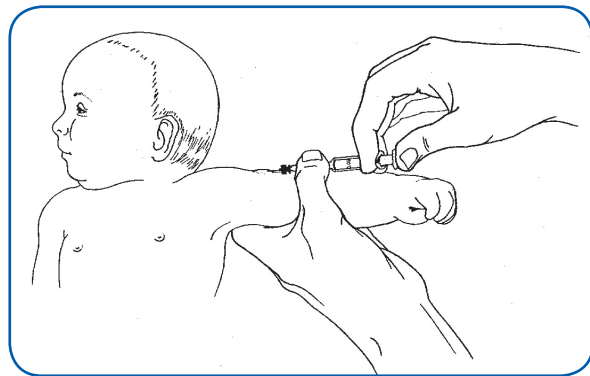

Note. When an intradermal injection is given correctly the plunger is hard to push. If the vaccine goes in easily you may be injecting too deeply. **Stop** injecting immediately, correct the position of the needle, and give the remainder of the dose, but no more.

If the whole dose has already gone under the skin, count the infant as having received a dose of vaccine. **Do not** repeat the dose. Ask the parent to return with the child if he or she shows any side-effects, such as abscesses or enlarged glands.

If you have injected BCG correctly, a flat-topped swelling appears on the skin. The swelling may look pale with very small pits, like an orange peel. If the technique is incorrect, the vaccine will go in easily and no swelling will be visible.

3.7 DTP or DTP-HepB or HepB, Hib vaccine: intramuscular (IM) injection in thigh

1. Position the infant sideways on the mother's lap with the infant's whole leg bare.
2. The parent should hold the infant's legs.
3. Gently stretch the skin flat between your thumb and forefinger.
4. Insert the needle at a 90° angle.
5. Quickly push the entire needle straight down through the skin and into the muscle. Inject slowly to reduce pain.

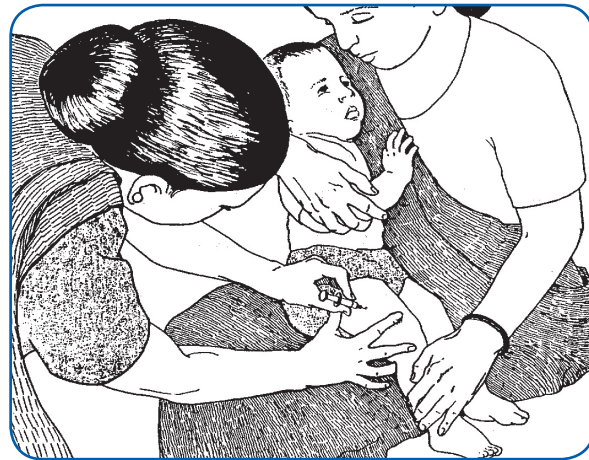

Intramuscular injections for older children and adults

Diagram showing how to locate the site to give IM injection to infants

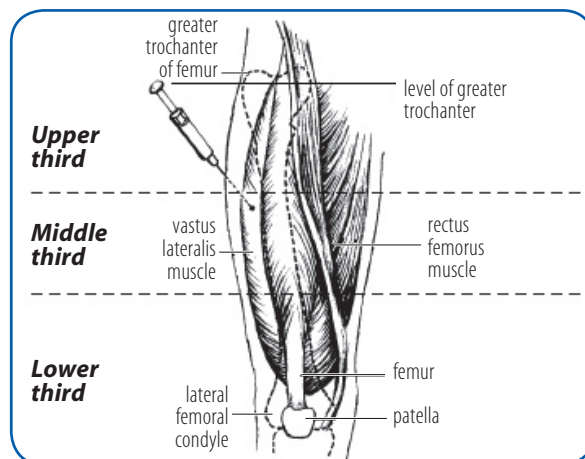

For vaccinating older children, adolescents and adults, the deltoid muscle of the upper arm may be used. In infants and young children under 15 months of age the deltoid muscle does not provide a safe intramuscular (IM) site due to the superficiality of the radial nerve and the deltoid muscle being insufficiently developed to absorb medication adequately.

Diagram showing how to locate deltoid

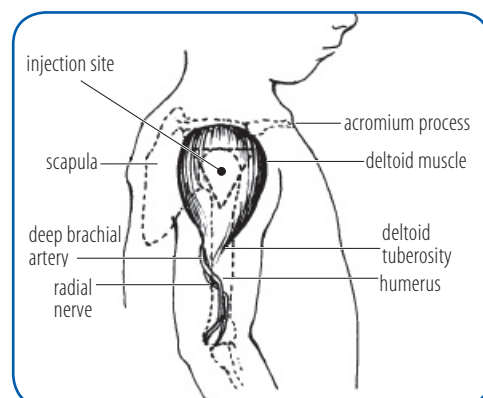

3.8 Measles vaccine, yellow fever, JE: subcutaneous (SC) injection

1. Position infant sideways on mother's lap with the whole arm bare.
2. The parent should hold the infant's legs.
3. Reach your fingers around and pinch up the skin.
4. Quickly push the needle into the pinched up skin – the needle should point towards the shoulder.
5. To control the needle, support the end of the syringe with your thumb and forefinger but *do not touch the needle*.

**3.9 OPV administration**

1. Ask the parent to hold the infant with the head supported and tilted slightly back.
2. The chin and cheeks should be dry: OPV is less likely to spill out.
3. Open the infant's mouth gently, either with your thumb on the chin (for small infants) or by squeezing the infant's cheeks gently between your fingers.
4. Let 2 drops of vaccine fall from the dropper onto the tongue. Do not let the dropper touch the infant.

**3.10 TT vaccine (for women): intramuscular (IM) injection in the left arm**

1. Ask the woman to sit down.
2. Tell her to drop her shoulder and place her left hand behind her back or resting on the hip. This relaxes the muscle in the arm and makes the injection nearly painless.
3. Put your finger and thumb on the OUTER part of the upper arm.
4. Use your left hand to squeeze up the muscle of the arm.
5. Quickly push the needle straight down through the skin between your fingers. Go deep into the muscle.
6. Press the plunger with your thumb to inject the vaccine.
7. Pull out the needle quickly and smoothly and ask the woman to press the site gently with a cotton pad in case of bleeding.

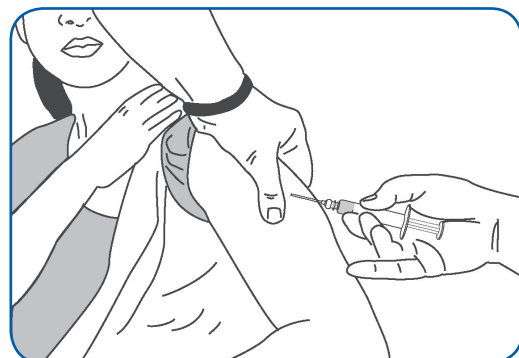

3.11 Vitamin A supplementation

1. Check the expiry date on the label. If the expiry date has been reached, discard the bottle.
2. Open the bottle and write the current date on the label so that you will know when to stop using it. Opened bottles of vitamin A capsules are good for one year.
3. Open a capsule by cutting the tip or nipple off with a clean pair of scissors or a clean nail clipper.
4. Squeeze the capsule firmly so that the drops fall into the mouth of the client. For a young child, you may need to pinch his or her cheeks gently to open the mouth.

! Give the correct amount of vitamin A supplement: too much can cause harmful side-effects.

If you are giving vitamin A to children ages 6 through 11 months and you have only 200 000 IU dose capsules, you need to know the number of drops in this size of capsule in order to be able to give a half dose (100 000 IU). To do that:

- 1 ▶ Open one 200 000 IU capsule, and squeeze out the contents while counting the number of drops that are contained in it.
- 2 ▶ Divide the total number of drops by two – this is the number of drops equal to a half-dose or 100 000 IU. It is safe to assume that all capsules in a batch contain the same number of drops.

4 Completing the tally sheet and infant's immunization card

4.1 Recording the vaccines and vitamin A supplement given on the tally sheet

Soon after you finish immunizing the infant and woman, record a mark for each vaccine and vitamin A supplement given on the tally sheet (more information in Module 7).

4.2 Completing the infant immunization card

- Complete the immunization card by writing down the date for each vaccine administered or vitamin A supplement given and return the card to the parent. If there is no special place on the card for recording vitamin A supplementation, write “Vit. A” and the date in the margin or any blank space on the card.

Immunization cards should be kept by the parents and not by the health staff.

- Mark the next immunization date on the card after every dose, and tell the parent when and where to return for the next dose of vaccine.
- Tell the parent that the card must be kept in good condition. Explain that it is an important document because it keeps track of her infant's health and immunization status and will help health workers understand how to treat her infant in the future.
- Tell the parent that the card should be brought along every time the infant comes to the health centre, whether or not the infant is coming in for services or not.
- Ask to see immunization cards for both mothers and infants every time they come to your health centre. Assess whether they are eligible for any vaccine or vitamin A supplementation. Do not miss an opportunity to immunize.

Updating the reminder cards

If you have a system of using reminder cards to track defaulters (see Module 7, Section 1.4), refer to the reminder card at each visit and update it at the same time as the immunization card.

4.3 Immunization cards for women

Women may have routine or supplementary TT doses recorded in three ways (see Module 7 for details):

- 1** ▶ On a life-long immunization card (most preferred)
- 2** ▶ On the antenatal card
- 3** ▶ On the infant's immunization card (for additional recording).

When screening women for TT immunization, always ask if the woman has a card. If she does not, ask if she can remember receiving TT immunization during this pregnancy if she is pregnant, and previous pregnancies if she is not, or during SIAs. We know from surveys that have compared women's response to the TT antibodies in her blood, that women are likely to remember TT doses accurately. You can then give the appropriate TT dose according to her history and tally accordingly. Also give her a card if she does not have one.

5

Communication with parents during and after the immunization sessions

Here are some guidelines on how to communicate with people about immunization. These should be adjusted depending on the time available, the number of people waiting, and weather conditions.

The most essential elements of every encounter are:

- that you treat the person with respect;
- that you advise him or her of possible side-effects and what to do about them; and
- that you explain when and where the next immunization session will be held.

5.1 Here is a step-by-step guide to talking about immunization with parents at a session

1. Thank the parent for coming to the immunization session and for their patience if they had to wait.
2. Explain in simple terms the diseases the vaccines protect against.
3. Describe the side-effects of immunization and what to do about them (see Module 2). Advise the parent on how to tell when they need to bring the infant to the health centre or hospital in case of a rare, serious side effect.
4. If the immunization is one dose of vaccine in a series, explain that the infant must complete the series in order to be fully protected. Use the chart on the immunization card as a guide, and congratulate the mother if the infant has completed the series.
5. Write the date for the next immunization on the card, and tell the parent the date as clearly as possible. Try to associate the date with a holiday or local event, which will help them remember when to return.
6. Tell the parent when and where to go to receive the infant's next immunization and vitamin A supplement.
7. If the parent and infant cannot come on that date, explain the alternative dates and times.
8. Tell women how many more times, when and where they must return to be fully protected against tetanus.
9. Remind the parent always to bring their immunization cards to the health centre or outreach session.
10. If the infant (or women) has missed some doses, do not scold the parents (women), but explain why it is important that an infant (women) needs to be fully immunized and that you will be giving (as much as possible) any missing doses during this

session. Also request to come timely for the next immunizations that are due (also give an appointment).

11. Inform the parent of any upcoming campaigns for TT, measles, or vitamin A, and of any National Immunization Days for polio.
12. Ask the parent if they have any questions.

Make sure you repeat each of these messages more than once if it seems necessary. Parents under stress – for example, in a busy clinic – may not remember well, so make sure they understand you. The likelihood parents will remember your messages increases if they hear the messages more than once.

5.2 Advising on potential side-effects

When advising a parent of the potential side-effects of any vaccine:

- Explain which disease or diseases the vaccine prevents.
- Reassure the parent that reactions are common and not a threat to the infant; they show that the infant is responding to the vaccine.
- If the infant suffers fever, pain, or swelling at the injection site, or is irritable, loses his or her appetite, or is “off colour”:
- Give extra fluids, that is, more breastfeeds or clean water.
- Paracetamol may be given – one 100 mg tablet crushed, three times in 24 hours.
- Give extra hugs and attention – but keep the pressure off the injection site(s).
- Place a cloth dampened with cold, clean water on the injection site.
- Tell the parent to bring the infant to the health centre if the infant’s condition gets worse or the reaction continues for more than a day or two.
- More details on side effects can be found in Module 2.

Potential side-effects, after giving BCG vaccine:

Explain to the parent that the flat-topped swelling on the infant’s arm is normal and indicates that the vaccine is working.

Ask the parent to return with the infant if he or she develops any side-effects, such as abscesses or enlarged glands.

Potential side-effects, after measles vaccine:

A rash or fever may develop after 6–12 days. Other people will not catch the rash and it goes away. Give extra fluids and keep child cool.

More details on side-effects can be found in Module 2.

6

Concluding the session

6.1 Completing an immunization tally sheet

Health workers should keep a tally of each immunization they give (see Module 7 for detailed instructions). At the end of an immunization session count the number of doses of each type of vaccine you have given, and use your daily tally sheets to prepare monthly reports to supervisors.

6.2 Taking care of the vaccines

- Opened vials of OPV, DTP, TT, DT, hepatitis B and liquid formulations of Hib vaccines may be used in the subsequent immunization sessions.
- Opened vials of measles, yellow fever and BCG vaccines **MUST** be discarded at the end of each immunization session or after 6 hours whichever comes first.
- Opened vials that can be used for the subsequent session should be kept in the refrigerator in a box marked “use first ” so they can be used first in the next session.

6.3 Taking care of vitamin A capsules

Storing vitamin A capsules

Vitamin A capsules do not need to be stored in a refrigerator and may be kept out of the cold chain but, like vaccines, they must be handled with care.

- They must be kept dry.
- They must be kept out of direct sunlight.
- They must not be frozen.

Store the 100 000 IU and 200 000 IU capsules in separate, labelled bottles to avoid mixing up the two doses.

When you open a new bottle, put the date on it. An opened bottle can be used no longer than a year or till the expiry date, whichever comes first.

6.4 Disposing of used equipment

- Used needles and syringes must be disposed of safely (see Module 4 for detailed instructions).
- Vials and rubbish should be wrapped in newspaper or other paper. If your local government does not collect them, either bury or burn them.

6.5 Special tasks on completing an outreach session

In addition to the tasks you have after a session at a fixed site, you must complete these tasks after an outreach session.

1 Pack the vaccine carrier

- Check the ice-packs to make sure that the ice has not melted. If the ice-packs have completely melted and/or the thermometer in the vaccine carrier shows a temperature above 8°C, the vaccine should be discarded unless it has a VVM which shows it is still safe to use.
- Pack unopened vaccines and open vials for which the multi-dose vial policy is applicable (see Module 3).
- Put empty vials and opened vials of reconstituted vaccines in a separate container to carry them to a disposal site.

2 Leave the outreach site tidy

- Do not leave anything behind that might be a health threat to the community.
- Collect safety boxes containing AD syringes and other rubbish, and bury or burn them at the site if possible (see Module 4). If not, take the safety boxes and other rubbish back to the health centre.
- Do not leave empty or opened vials at the site.
- Do not leave any syringes or needles at the site.
- Return tables, chairs, and other equipment to their owners.
- Thank the local people who have helped to organize the session and remind them when you will return.

3 Return vaccines to the refrigerator

- If the ice-packs in your vaccine carrier have melted during your trip back to the health centre, discard all of the vaccines except those whose vaccine vial monitor indicates that the vaccine is safe to use. Return these vaccines to the refrigerator and place in the “use first” box so they will be used first during the next session.
- If the ice-packs are still frozen, put unopened vials in the “use first” box in the refrigerator.
- Put the ice-packs from the carrier into the freezer, and check and record the temperature of the refrigerator.

4 Clean the vaccine carrier

Wipe the carrier with a damp cloth and check it for cracks. Repair any cracks with adhesive tape and leave the carrier open to dry.